

Datasheet

Features

- Cmos Colour Sensor :
 - 4096 RGB Pixels 5x5µm (Full Definition)
 - 2048 RGB Pixels 10x10µm (True Colour)
- Interface : NBASE-T™ (up to 5Gb/s)
- Line Rate :
 - 50 000 I/s In 4k Full Definition Mode
 - 100 000 I/s in 2k True Colour Mode
- Bit Depth : 24bits (RGB 8bits)
- Scan Direction
- Flat Field Correction
- Cycling Preset Modes and Memories
- Multi ROI
- Metadata
- Rotary Encoder



Description

To maintain their competitive advantage, industrial leaders in the machine vision market have a continuous requirement to improve defect detection accuracy and reduce the cost of imaging. The availability of the UNiiQA+ cameras with an NBASE-T™ connection offer a straightforward solution, providing:

- High throughput - enabling high resolution and colour imaging without a frame grabber at speeds of up to 5 Gigabits per second (Gbps) over Category 5e standard Ethernet cable.
- Easy integration – compatible with GigE Vision protocol.
- Long-length (100 meters+), field terminable, inexpensive cabling - reduces costs and enables easier integration in imaging systems compared with optic fibre cabling

Applications

- Raw material surface inspection
- Parcel and postal sorting
- High resolution document scanning
- Print and paper inspection
- Industrial Inspection



Key Specifications

Characteristics	Typical Value		Unit
Sensor Characteristics at Maximum Pixel Rate			
Resolution	4096	2048	RGB Pixels
pixel size (square)	5	10	µm
Max Line Rate	50	100	kHz
Radiometric Performance at Maximum Pixel Rate and minimum camera gain			
Bit depth	3 x 8		Bits
Response non linearity	< 1		%
PRNU HF Max	3		%
Dynamic range	65		dB
Peak Response (All Modes)			
Red	11.8		LSB 8bits/(nJ/cm ²)
Green	11.2		LSB 8bits/(nJ/cm ²)
Blue	7.8		LSB 8bits/(nJ/cm ²)

Test conditions :

- All values are given at Nominal Gain (0dB) : Preamp Gain x1, Amp Gain 0dB
- Figures in LSB are for a 8bits format
- Measured at exposure time = 400µs and line period = 400µs in Ext Trig Mode (Max Exposure Time)
- Maximum data rate

Functionality (Programmable via GenICam Control Interface)		
Analog Gain	Up to 12 (x4)	dB
Offset	-4096 to +4096	LSB
Trigger Mode	Timed (Free run) and triggered (Ext Trig, Ext ITC) modes	
Sensor Modes	<ul style="list-style-type: none"> • True Colour Single : 2048 RGB Pixels of 10x10µm • Full Definition Single : 4096 RGB Pixels 5x5µm 	
Mechanical and Electrical Interface		
Size (w x h x l)	60 x 60 x 55	mm
Weight	247/335 without/with Heat Sinks	g
Lens Mounts	C, F, T2, M42 (embedded in the Front Face)	-
Sensor alignment	±100	µm
Sensor flatness	±50	µm
Power supply	12 - 24	V
Power dissipation	< 11	W
General Features		
Operating temperature	0 to 60 (front face) or 85 (Internal)	°C
Storage temperature	-40 to 70	°C
Regulatory	CE, FCC and RoHS compliant	

Image Sensor and colour modes

The UNiQA+ Colour 4k/2k sensor is composed of 2 sensitive lines.

The Colour version has been completed with RGB colour Filter and disposed as detailed beside.

Each line uses a different Analog to Digital Column converter (ADC Column). An appropriate (embedded) Time delay in the exposure between each line this allows to fit green and Red/Blue in Full definition as well as the “binning” or synchronized exposure is used for the True Colour mode.

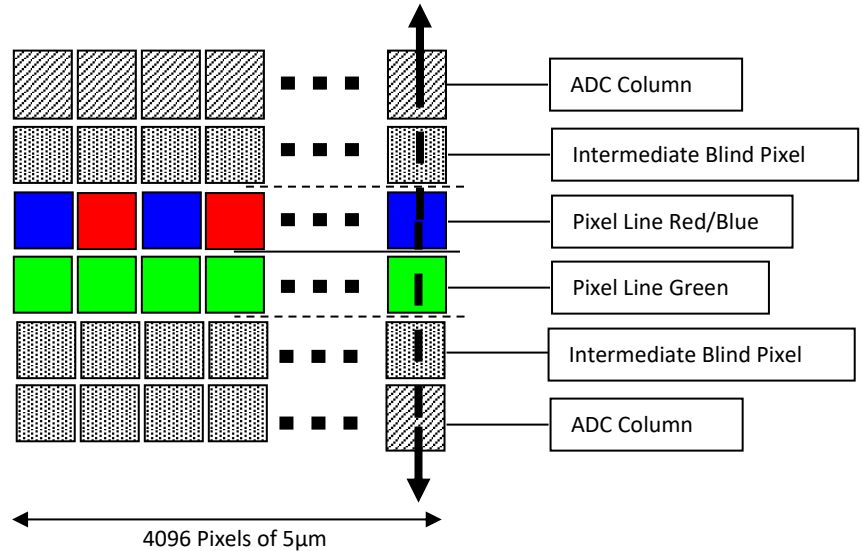

Full Definition Single Mode (FDS) or 4k 5µm

5µm Pixels (R,G,B)

Same definition than B&W

Requires x3 the data flow of the B&W

- Sensitivity is equivalent to the True Colour mode: Equivalent to 3 x Pixels of 5µm (with their respective colour filters).

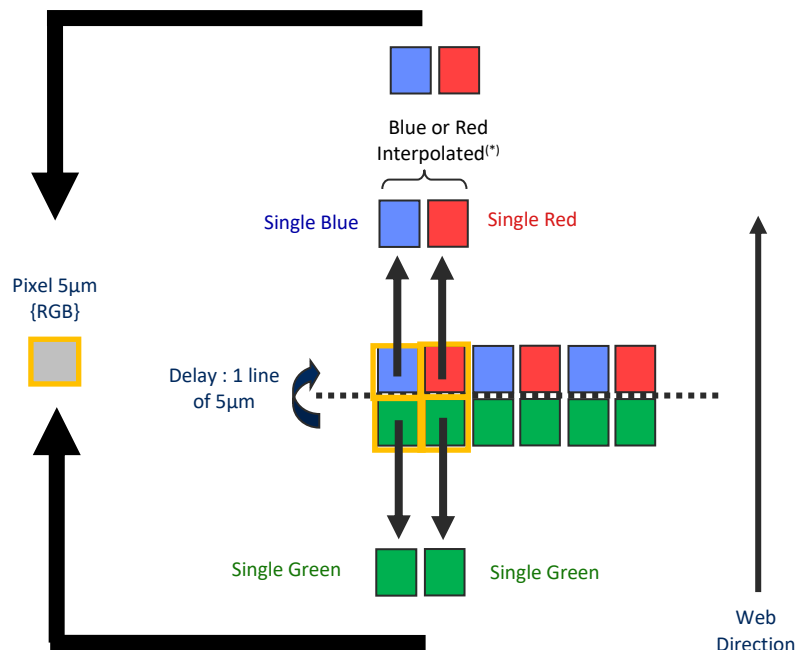

Colour Interpolation in Full Definition mode.

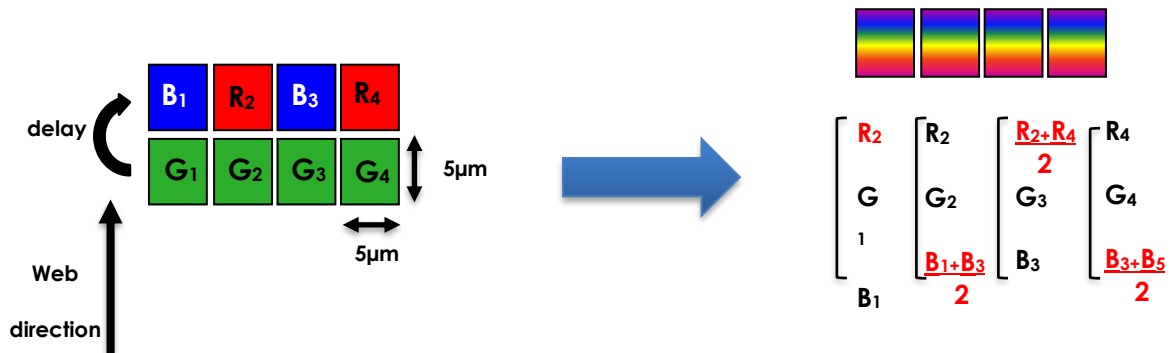

This colour mode (5µm) requires the indication of “Forward/Reverse” to the camera in order to manage the delay between the two coloured lines.

True Colour Single Mode (TCS) or 2k 10µm

10µm Pixels (R,G,B)
 Twice less pixels than B/W
 Requires x3/2 the data flow of B&W

- Sensitivity Half of the Full definition mode: Equivalent to 3 x Pixels of 5µm (with their respective colour filters).
- Not sensitive to the Scanning direction and the variation of the aspect ratio of the image.

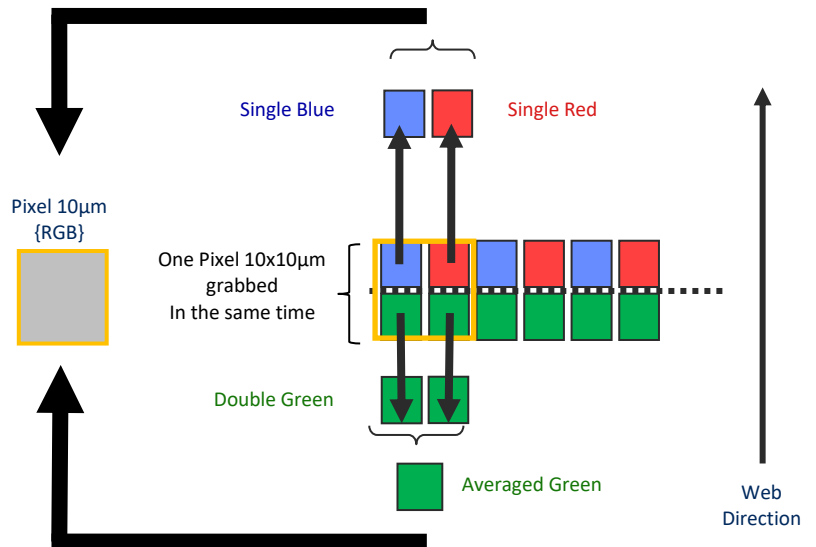

Column Interpolation Correction in True Colour

This interpolation is used to compensate the colour error in the Red or the Blue in case of a vertical transition on the web : The Red of the blue value of each coloured pixel is corrected if the variation between two neighbour green pixels is significant.

$B_1' = \alpha_B \times B_1$ and α_B is the blue correction, calculated with the variation $(G_1 - G_2)$

$R_2' = \alpha_R \times R_2$ and α_R is the red correction, calculated with the variation $(G_1 - G_2)$

- This interpolation is available only for pixel size 10x10µm (True Colour only)
- It can be disabled by the customer. By default, it is enabled.

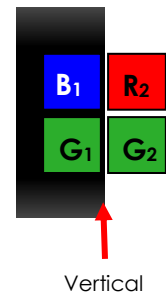

Line Interpolation Correction in True Colour

This interpolation is used to compensate the colour error in the Red or the Blue in case of a horizontal transition on the web in the same "True Colour" pixel : A line is memorized and the Red of the blue value of each coloured pixel is corrected if the variation between two consecutive green values (previous to next line) is significant :

$B_1' = \alpha_B \times B_1$ and α_B is the blue correction, calculated with the variation $(G_1 - G'_1)$

$R_2' = \alpha_R \times R_2$ and α_R is the red correction, calculated with the variation $(G_2 - G'_2)$

- This interpolation is available only for pixel size 10x10µm (True Colour only)
- It can be enabled by the customer. By default, it is disabled
- This interpolation requires the Forward/Reverse indication sent to the camera for the memorized line.

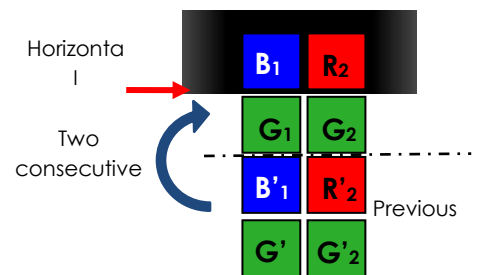

The Line Interpolation **has to be disabled** if the light is changing for each Line (typically for pulsed Light source with different spectrum) or for any reason the Green component of the light source changes significantly from one line to the next one.

Effects of the interpolation Corrections

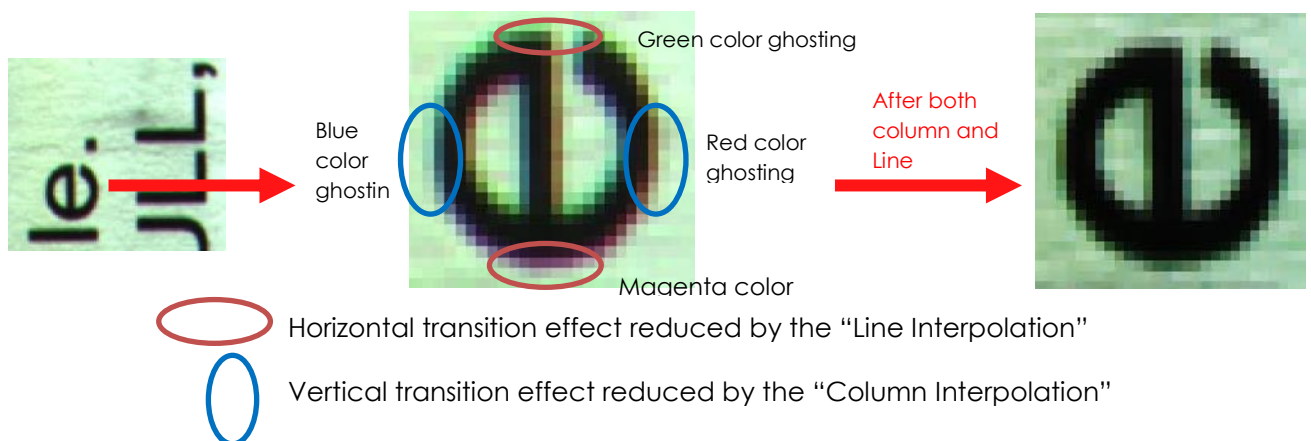

Response & QE curves

Quantum Efficiency

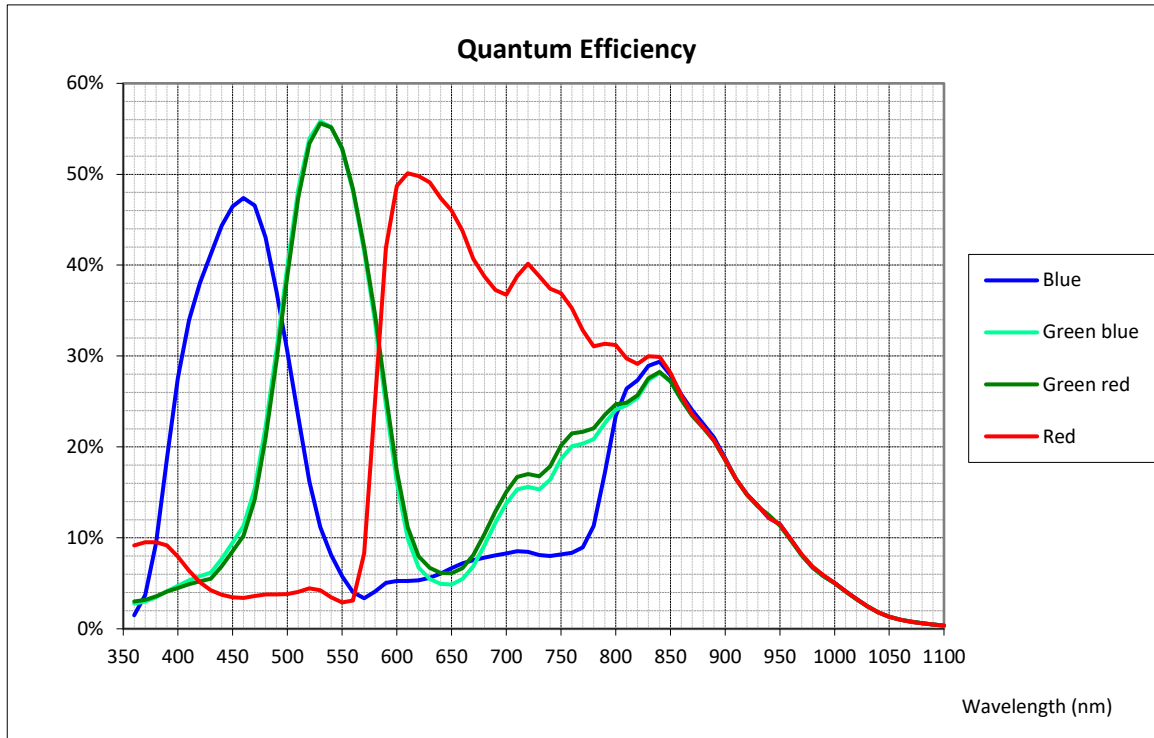

Spectral Response

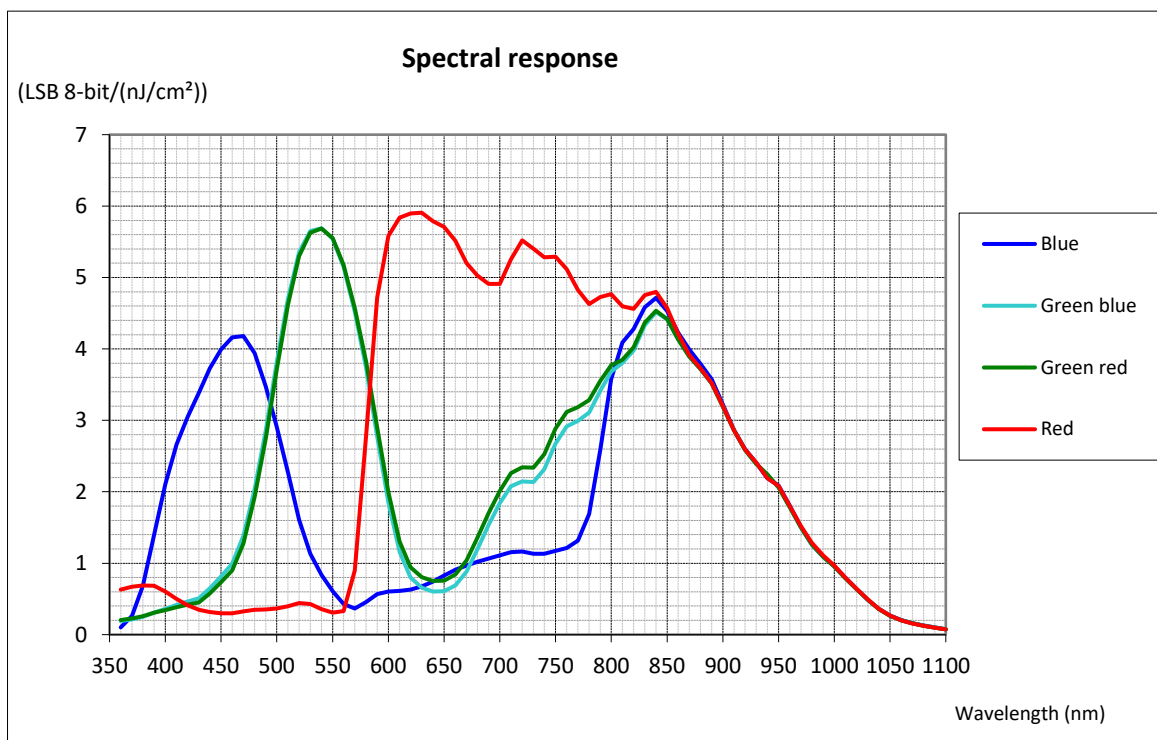

Camera Hardware Interface

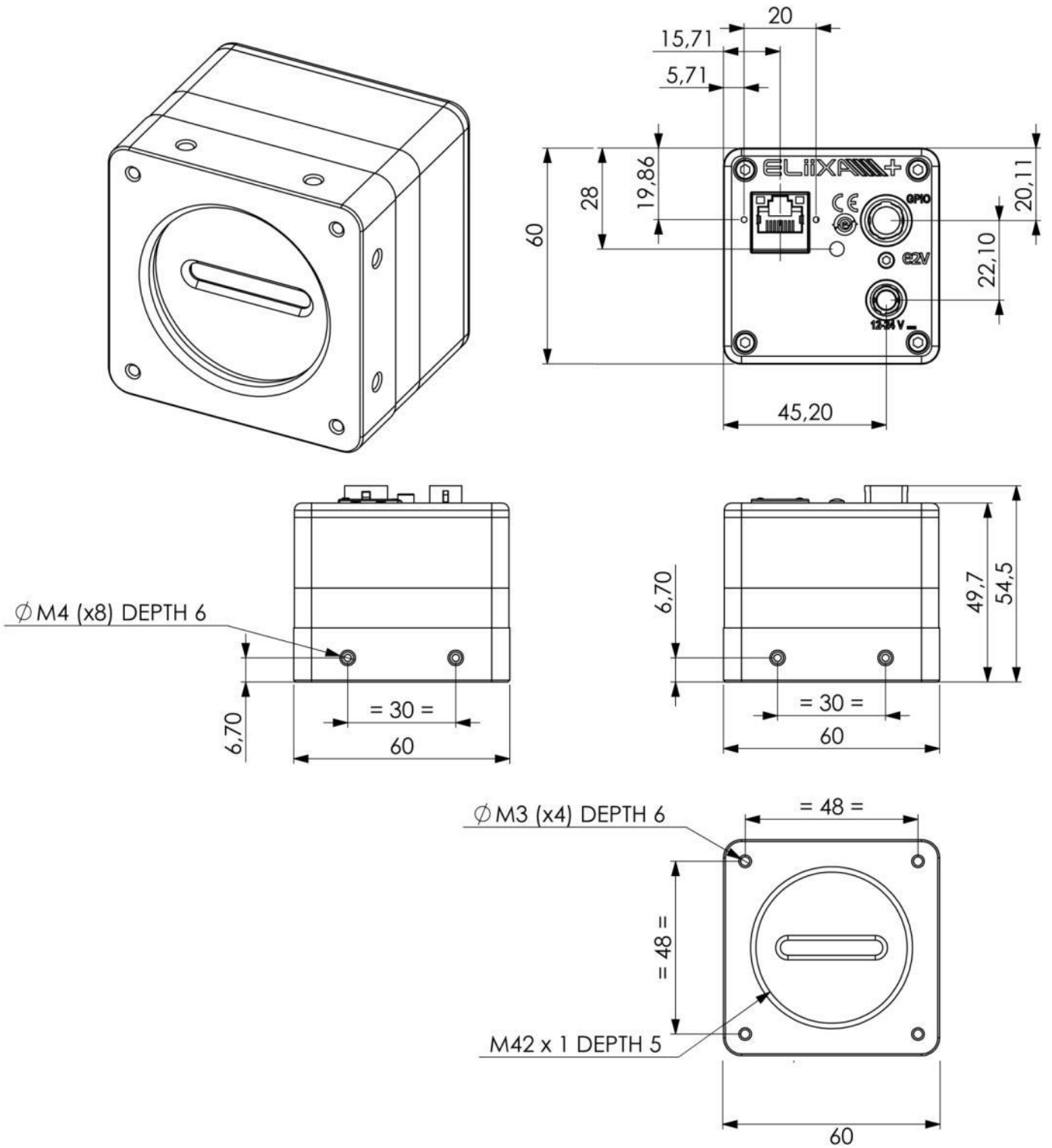

Input/output Connectors and LED



Power Connector

Camera connector type: Hirose HR10A-7R-6PB (male)

Cable connector type: Hirose HR10A-7P-6S (female)

Signal	Pin	Signal	Pin
PWR	1	GND	4
PWR	2	GND	5
PWR	3	GND	6

Power supply from 12 to 24v
 Power 11W max with an typical inrush current peak of **1A** during power up

GPIO Connector

Camera Connector type: Hirose HR10A-10R-12SB

Cable Connector type: Hirose HR10A-10P-12P

Cable type: cable immune from interference and with twisted pairs

Signal	Pin	Signal	Pin
Line 0+	1	Line 3+	7
Line 0-	2	Line 4+	8
Line 1+	3	Line 5+	9
Line 1-	4	Line 6+	10
Line 2+	5	GND	11
Line 2-	6	GND	12

Lines 0, 1 and 2

The GPIO Connector allows the following connections :

- Line 0, 1 or 2** : Dedicated inputs for Line Triggers and Frame Trigger. Differential (RS422 with or without termination) or TTL (Single End) in 3.3V, 5V, 12V or 24V.

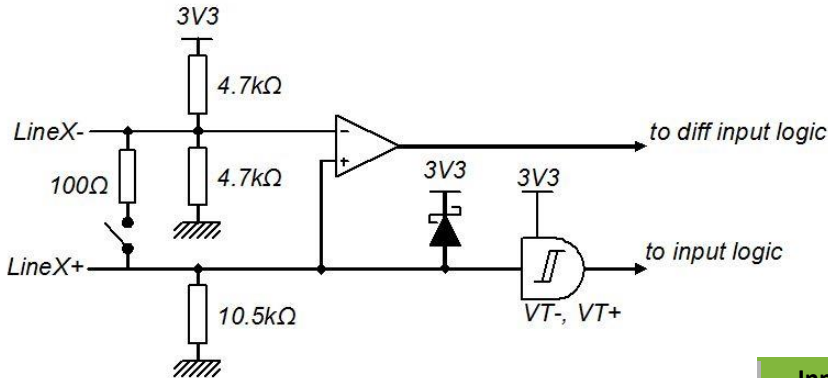

Input Thresholds	VT- Min	VT+ Max	Unit
24V	5.5	10.7	V
12V	2.9	5.5	V
3.3 / 5V	0.8	1.5	V

Lines 3, 4, 5 and 6

- Line 3, 4, 5 and 6** : Configurable Inputs or Outputs in TTL only :
 - Input Configuration : Single End in 3.3V, 5V, 12V or 24V
 - Output configuration : Single End or Open Collector in 3.3V, 5V, or Camera power Supply

INPUT Configuration

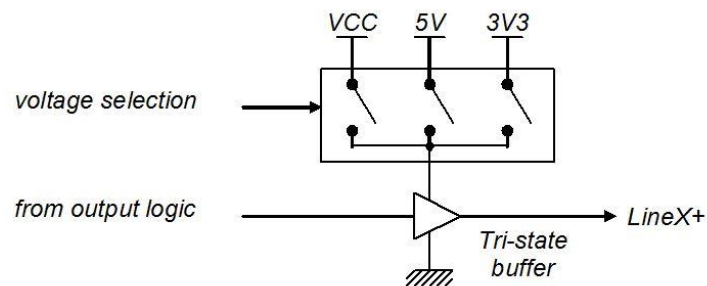

OUTPUT Configuration

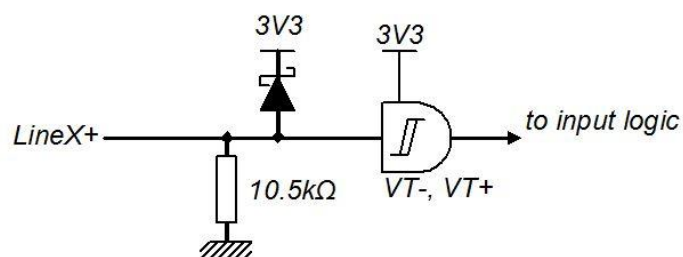

Camera Interface : NBASE-T™

What is the NBASE-T™ Technology ?

NBASE-T™ technology defines a new type of Ethernet signaling that boosts the speed of installed based twisted-pair cabling well beyond the cable's designed limit of 1 Gigabit per second (Gbps) for distances up to 100 meters. Capable of reaching 2.5 and 5 Gbps using the large installed base of Cat5e and Cat6 cabling, NBASE-T™ solutions enable users to accelerate their networks in the most cost-effective, least disruptive manner.

Flexible silicon solutions can auto-negotiate the optimal network speed, be it the new NBASE-T™ rates, slower 2.5 Gbps and 5 Gbps rates, or—if the network infrastructure supports it—10 Gbps

To introduce these new cameras, e2v has partnered with Pleora Technologies, the world's leading supplier of high-performance video interfaces, the first company from the machine vision industry to join the NBASE-T™ Alliance, a consortium collaborating on new technologies that extend the bandwidth capabilities of twisted-pair copper cabling using standard Ethernet technology.



Then all NBASE-T™ UNiiQA+ are licensed for Pleora eBus SDK and PureGeV Software that you can download on Pleora website (<http://www.pleora.com/our-products/ebus-sdk>)

Camera Interface : GPIO

General Inputs/Outputs Management

The GPIO Modules allows the connection of 7 external Lines :

- 3 dedicated inputs : 2 Line Triggers (LT1 and LT2) and one Frame Trigger (FT)
- 4 convertible generic Inputs / Outputs

A flexible in/Out block in RS422 or TTL with different detection levels (3.3v, 5v, 12v, 24v/Camera Power Supply) with a lot of features :

- Debounce filter and Inverter on each Input
- A delay dedicated to the Frame Trigger only (FT)
- A Full Rotary Encoder management (Quadratic with or without reverse miscount)
- A Rescaler following the Rotary Encoder module (available also if Rotary Encoder is bypassed)
- 2x Counters and 2x Timers
- 4x Outputs which can be set on Software, Start Frame or each individual Cycling Preset mode used.

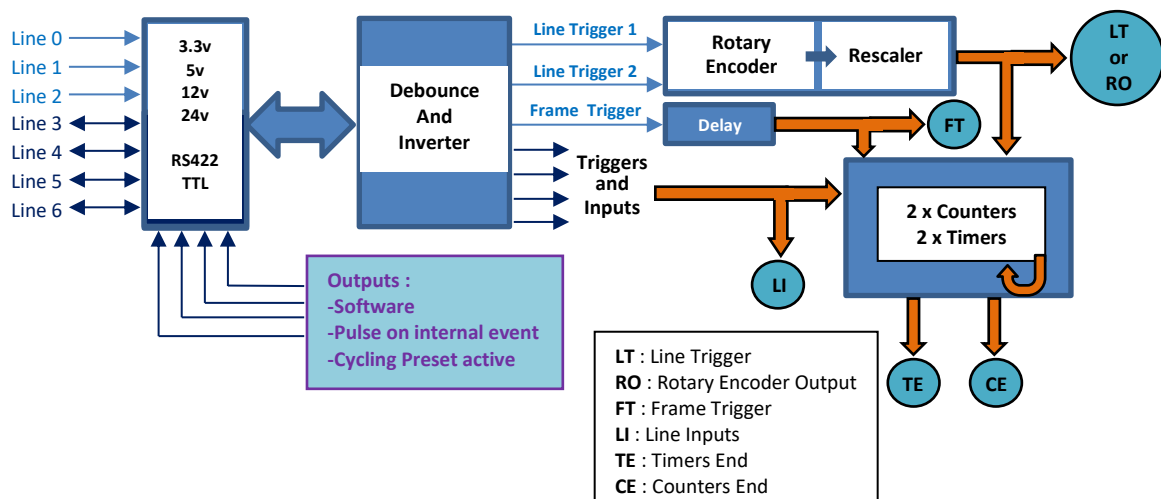

GenICam Triggers

Three GenICam Triggers can be configured :

- **Frame Start Trigger**
 On the Rising/Falling Edge of any of the following signals :
 - Frame Trigger (FT)
 - Timer End (TE1/TE2)
 - Counter End (CE1/CE2)
 - Software
- **Frame Active Trigger**
 On the High/Low Level of any of the following signals :
 - Frame Trigger (FT)
 - Timer End (TE1/TE2)
 - Counter End (CE1/CE2)
 - Software
- **Line Start Trigger**
 On the Rising/Falling Edge or High/Low Level of any of the following signals :
 - Rotary Encoder Output (RO)
 - Line Trigger (LT1/LT2)
 - Timer End (TE1/TE2)
 - Counter End (CE1/CE2)

The Exposure starts at the end of a User's configurable delay after the Line Trigger rise

Rotary Encoder

The Embedded Rotary Encoder is managed by the two inputs Lines :

- LT1 taken as "A" quadrature input
- LT2 taken as "B" quadrature input

The Encoder takes in account the Forward/Reverse indication given to the camera (by software or external input) to determine the forward or Reverse position of the A and B quadrature inputs. Its "Forward/Reverse" outputs is just an indication of its working mode as soon as it is not disabled but has no action on the camera scanning direction.

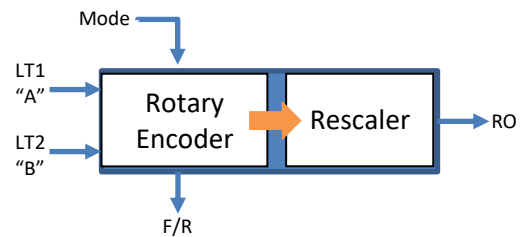

The Output of the Rotary Encoder enters a Rescaler (Multiplier / Divider) that can be also bypassed (neutral). The Rotary encoder has two working modes :

- Quadratic without miscount : The Encoder is sending only forward lines. Any reverse line is not sent and not counted.
- Quadratic with miscount : The Encoder is sending only forward lines but reverse lines are miscount in an internal counter. The Encoder will restart sending Line triggers as soon as each reverse Line miscounted has been recounted forward.

The Rotary Encoder can be bypassed. Then the "B" input is disabled and the Line Trigger 1 (LT1) connected on input "A" is passing through the Rotary encoder to enter the Rescaler

The Rotary encoder can't be used by changing the camera operation (Forward/Reverse) "on the fly" as some sensor modes require some reset and some time to change the scanning direction.

Counters

Two Counters are available to count any edge of the following information :

- Line Triggers (LT1/LT2)
- Frame Start
- Line Start
- End of the other counter (CE1 or CE2)
- End of any Timer (TE1 and TE2)
- Line inputs (L3 to L6)

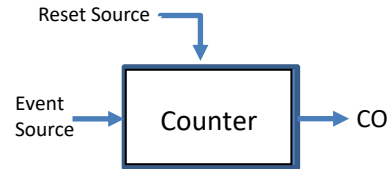

The counter Duration is set and when the counted value reaches the duration, the Output of the counter rises to 1. If the reset input of the counter is not set (Off), the counter resets immediately : The end count value is set in the “Value at Reset”, the output is reset and Counter restarts counting on the same event.

The Reset input of the counter can be set on any of the following signal :

- Line Triggers (LT1/LT2)
- Frame Trigger
- Acquisition Start
- Acquisition End
- Line Inputs (L3 to L6)
- Software

As soon as the Reset input is set but not active, the counter counts. If it reaches the duration before any reset, the output rises to 1 and the counter carries on counting. Then if the Reset arises, the “Value at Reset” is set with the current value (even higher than the duration), the output is set to 0 and the counter can restart counting on the same even as soon as the reset input switches down to 0.

If the Reset arises before the counter has reached the duration, the “Value at Reset” is set with the current value (even Lower than the duration), the output is set to 0 and the counter can restart counting on the same even as soon as the reset input switches down to 0.

Timers

Two Timers are available and start their timing any edge of the following information :

- Line Triggers (LT1/LT2)
- Frame Start
- Line Start
- End of the other counter (CE1 or CE2)
- End of any Timer (TE1 and TE2)
- Line inputs (L3 to L6)

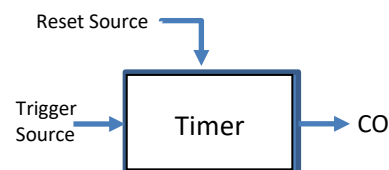

The Timer Duration is set and when this value is reached, the Timer output rises to 1. If the Reset source is not set (Off) then the Timer resets immediately : The output is reset and Timer restarts after the same event edge.

As soon as the Reset input is set but not active, the timer Output remains to 1.

When the Reset arises, the output is set to 0 and the Timer can restart as soon as the reset input switches down to 0. If the reset arises before the end of the Timer duration, the Timer is reset without switching to 1 and can restart as soon as the reset input switches down to 0.

Cycling Preset modes and configuration

The Cycling Preset mode is the possibility for the camera to switch at least for each line between 4x sets of pre-defined parameters including :

- Exposure Time and Exposure Delay
- Flat Field Correction
- Gain (Amplification Gain)
- White Balance Gains
- RGB Colour Correction Matrix

The Cycling Preset mode configuration allows up to 8 different steps for switching between this choice of 4 sets of parameters and thus with the arising of different possible events (Line Input, Line Trigger, Frame Trigger, end of Counter and/or Timer ...) :

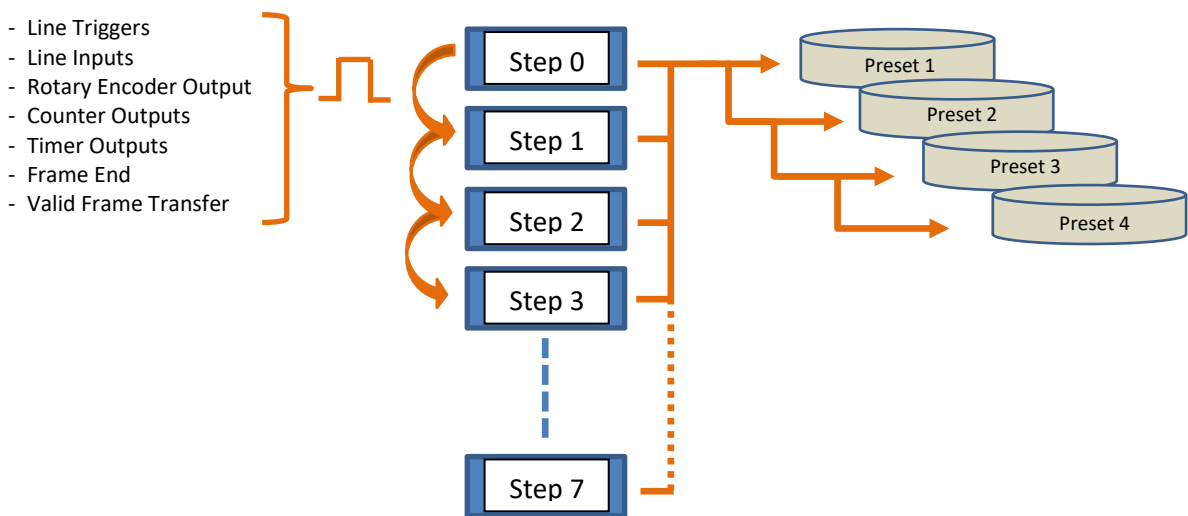

Models

Part Number	Definition	Max Speed	Details
EV71YC1CNT4005-BA0	4k x 5µm	50kHz	Delivered with a pair of Heat Sinks
EV71YC1CNT2010-BA0	2k x 10µm	100kHz	